

Panel Glide System

Silent Gliss® 2500

6056

3 channel

1:2

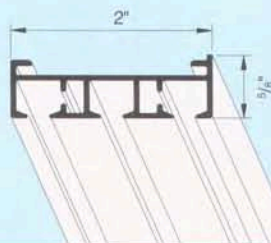

6054

4 channel

1:2

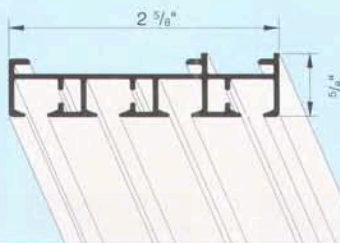

6055

5 channel

1:2

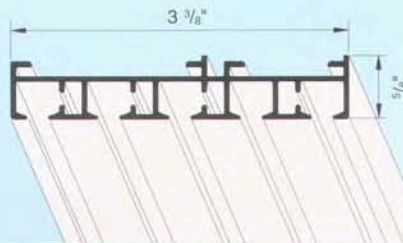

Product Information

- #2500 is a unique, multi-channel, flat panel moving system for window treatment, room division, wall decoration or display applications
- Appropriate for both residential and contract requirements
- Suitable for use with blackout, sunscreen, soft decorative and technical fabrics
- Hand draw, with or without batons, cord draw and motorized operating versions are available
- Fabric panels are easily removed for cleaning or for changing room decor
- One way draw, split draw or random stacking arrangements are possible
- Delrin panel carriers ensure smooth, silent panel movement
- Simple wall mount or ceiling mount installation options
- Profiles available in standard clear anodized aluminum finish or custom painted white
- Widths up to 40 feet for split draw applications
- 5 Year Warranty

Cannot be bent

Installation

Ceiling Fixing

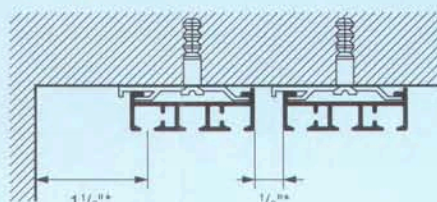

* Recommended minimum distance

Bracket
0824

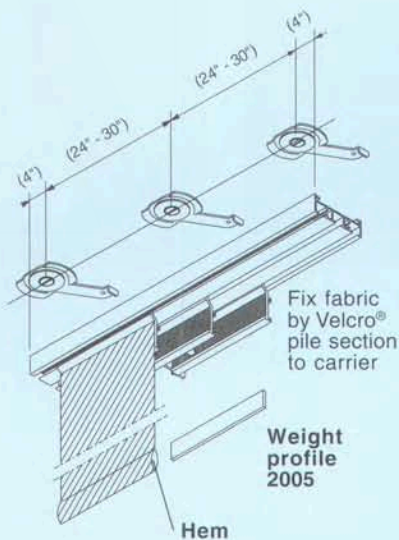
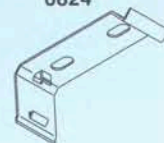

Fix fabric by Velcro® pile section to carrier

Weight profile
2005

Hem



Clamp 3003
for profiles 6054, 6055, 6056

Wall Bracket Installation

Single Profile Bracket Installation



Multiple Profile Bracket Installation

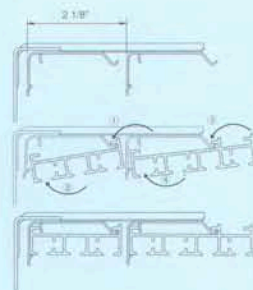

Panel Glide System Silent Gliss® 2500

Installation

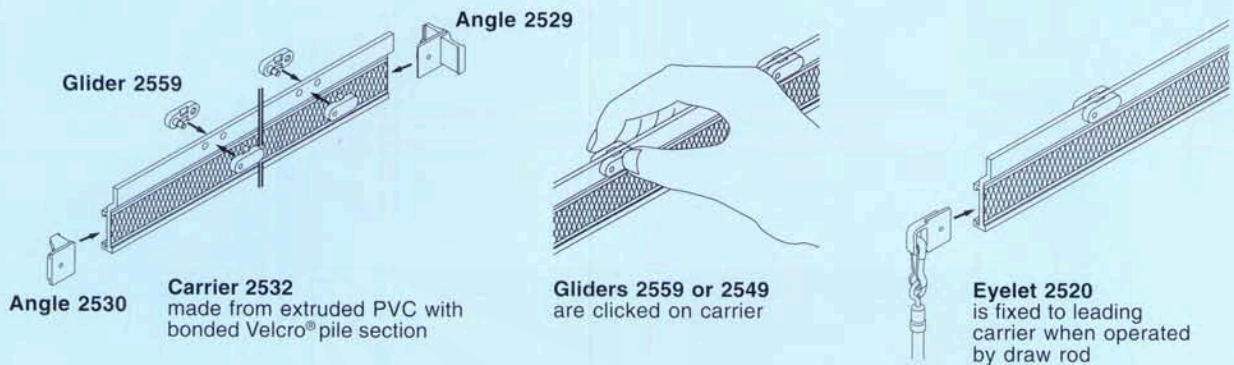

Operating Methods

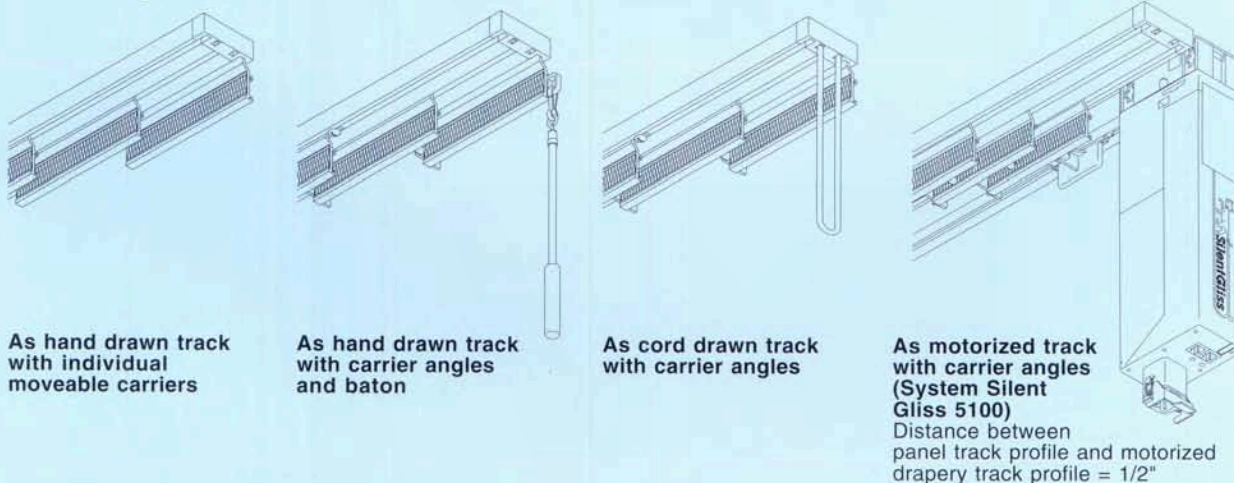

Frequent combinations of profiles

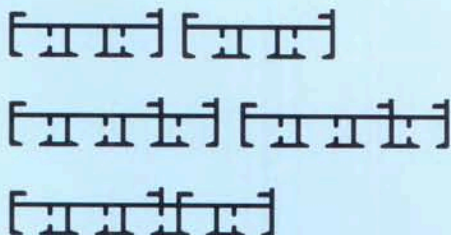

Distance between profiles = 1/8"
All profiles are best ceiling fixed

Stacking and arrangement possibilities

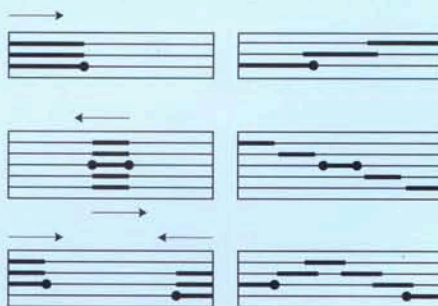

These are only a few variation possibilities
● (Indicates fixed panel)

Panel Glide System Silent Gliss® 2500

Accessories

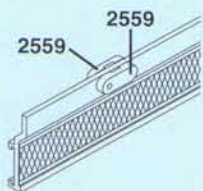

PVC carrier 2532
complete with bonded Velcro® pile section and 2 gliders 2559

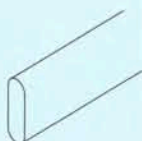

Weight bar 2004
0.330 kg/m



Glider 2559
for PVC carrier 2532

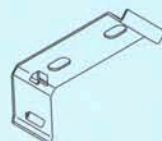

Bracket 0824



Angle 2530



Angle 2529



Endstop 6013



2539 Velcro® loop

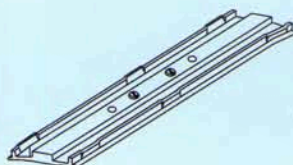

Connecting bridge 3008
for profile 6003

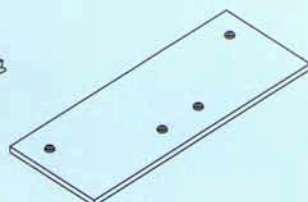

Connecting bridge 6024
for profiles 6054, 6055, 6056

Components

for hand operated systems

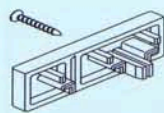

Endcover 2535
for profile 6003, 6056

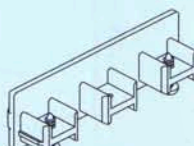

Endcover 2518
for profile 6056

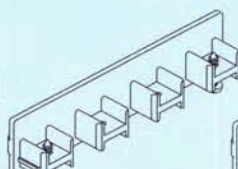

Endcover 2519
for profile 6054

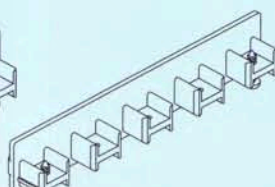

Endcover 2533
for profile 6055



Eyelet 2520
for draw rod



Draw rod

Components

for cord operated systems

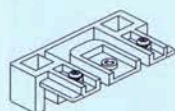

Cord Guide 2502
for profile 6056

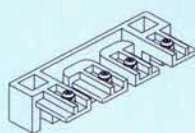

Cord Guide 2505
for profile 6054

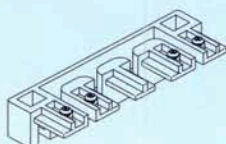

Cord Guide 2501
for profile 6055



Cord 3090
1/4"



Pilot Runner 2558

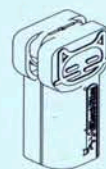

Cord Weight 3040