

Heavy Duty and Stage Curtain Track System Silent Gliss® 6200

Specification guide

Silent Gliss 6200 curtain track, cord drawn, anodised aluminium, assembled complete with roller gliders 6098 at 10/m, cord guide/returns 6212/6213, pilot runners 6214/6227, overlap 6079, cord 6070 (cord drop 3000mm R.H.S.) and endstop 6007, top fixed with clamp 6209 at

approx. 600mm centres plus cord guide, each screwed to timber/plugged and screwed to blockwork/concrete.

..... Lm. in lengths.

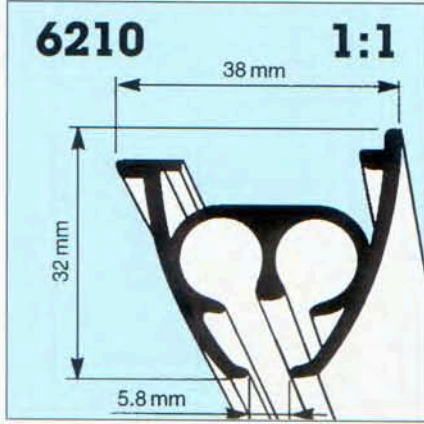

Fitting

Ceiling fix with clamp 6209

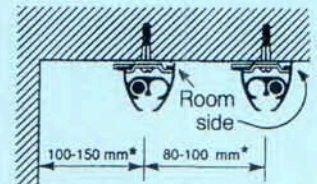
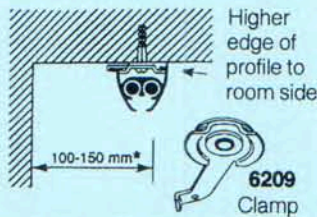

Wall fix with fixed extension bracket 3239 and clamp 6224

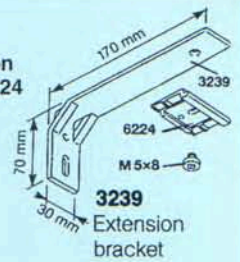
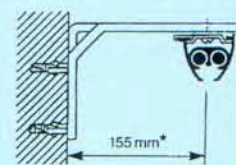

System 6202 parallel double system

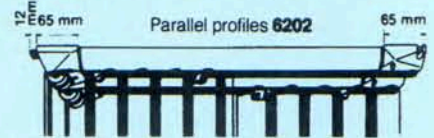

*Dependent on curtain weight, and any obstructions

Product Information

- Unbeatably efficient with effortless closing of curtains up to 90kg in weight and up to 25m in length.
- Heavy duty pulleys and Delrin rollers.
- For very heavy curtains for small stages, conference rooms, sports halls etc. and very heavy domestic curtains.
- Elegant rounded profile more attractive than any competitive system of its size. Same appearance both sides for room dividing.
- Standard lengths 4/5/6m. Silver only. Connecting bridge available.
- Can be used as a parallel system with one cord pull only and infinite overlap, (ideal for stages).
- Fix every 600mm.
- Standard cord drop 300cm.

Can be bent
Min. radius R
6210= 350mm

Standard Accessories

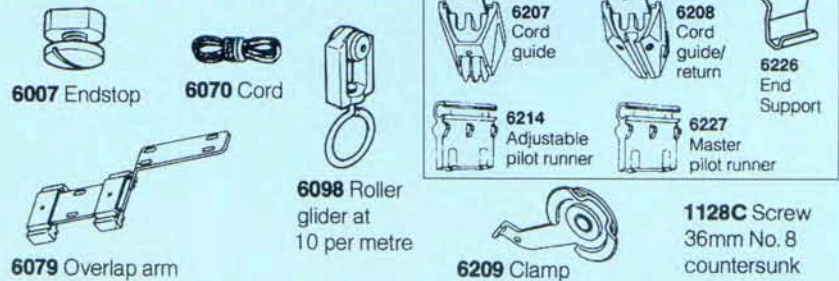

Optional Accessories



Max. Curtain Weight

| | 3m | 6m | 9m | 12m | 15m | 20m | 25m |
|--|----|----|----|-----|-----|-----|-----|
| | 85 | 80 | 75 | 70 | 65 | 57 | 48 |
| | 95 | 89 | 84 | 77 | 72 | 62 | 54 |
| | 51 | 48 | 45 | 41 | 37 | 32 | 26 |
| | 56 | 54 | 50 | 46 | 43 | 36 | 31 |
| | 42 | 38 | 35 | 31 | 27 | 22 | 16 |
| | 46 | 43 | 39 | 35 | 32 | 26 | 20 |
| | 65 | 61 | 57 | 53 | 50 | 43 | 35 |
| | 75 | 70 | 66 | 62 | 56 | 50 | 42 |