

Owner's Guide

Provenance® Woven Wood Shades

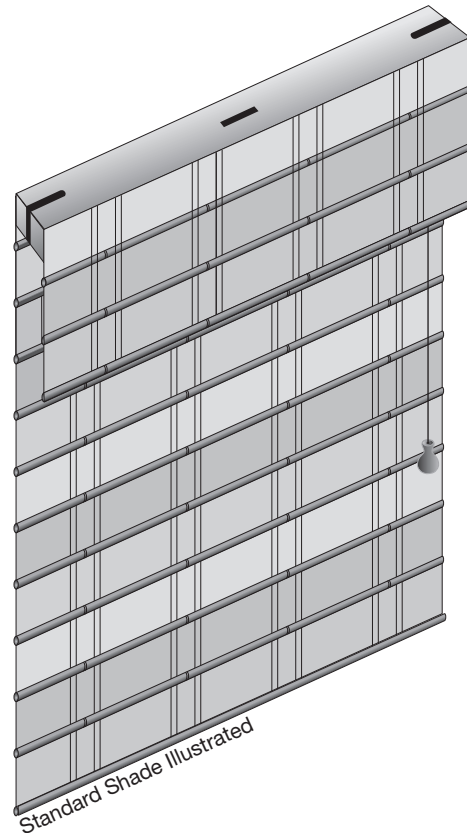

Standard Cord And
Clutch Operated Shades

HunterDouglas

CONTENTS

Introduction.....	2
Before You Begin.....	2
Product View	3
Getting Started.....	4
Tools And Fasteners Needed.....	4
Mount The Installation Brackets	4
Install The Shade.....	6
Secure The Cord Tensioner	7
Operate The Shade.....	8
Adjust The Shade	9
Remove The Shade.....	9
Care And Cleaning.....	9
Child Safety	10
Troubleshooting	11

INTRODUCTION

THANK YOU for purchasing a Hunter Douglas Provenance® woven wood shade. Your new shade has been custom built for you from the highest quality materials.

BEFORE YOU BEGIN

Please review the instructions to acquaint yourself with all of the procedures.

If you need any assistance with operation or adjustments, call the Hunter Douglas Customer Information Center toll free at:

1-888-501-8364

PRODUCT VIEW

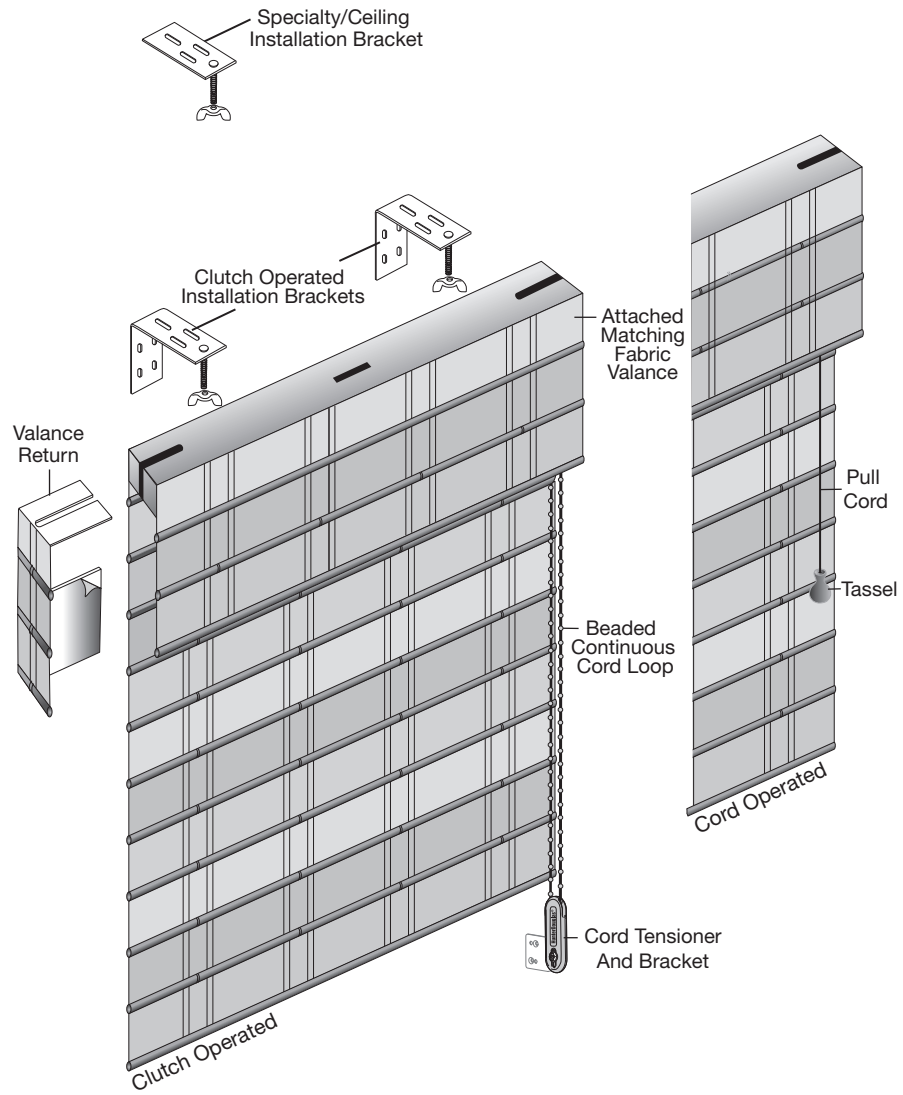

GETTING STARTED



- Remove the materials from the package. Keep the packaging until the shade meets your satisfaction.
- Save these instructions for care and cleaning, shade removal, and reinstallation procedures.
- Check the *Product View* to make sure you have all of the necessary parts. Contents of the hardware package may vary depending upon how the shade was ordered and how the shade will be mounted.

TOOLS AND FASTENERS NEEDED

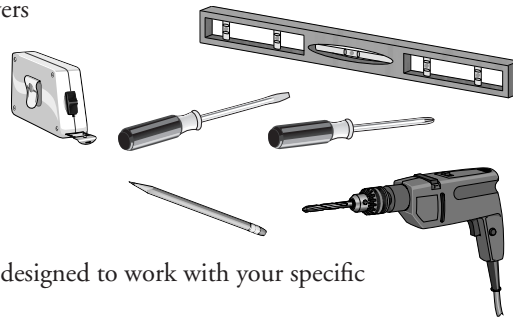
- Flat blade and Phillips screwdrivers
- Level
- Measuring tape
- Pencil
- Power drill, 1/4" driver, and drill bits

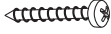

In addition, you will need fasteners designed to work with your specific mounting surfaces:

Mounting Surface	Fastener
Wood	No. 6 Hex Head Screws (Provided) 
Drywall, Plaster	Wall Anchors, Expansion Bolts (Not Provided) 
Metal	Sheet Metal Screws (Not Provided) 

MOUNT THE INSTALLATION BRACKETS

Bracket Placement

- The number of brackets is determined by the shade width.

Shade Width	Brackets Required
18" - 36"	2
36 1/4" - 72"	3
72 1/4" - 96"	5
Two- And Three-On-One Headrail	5

- Hold the shade in the window opening to mark the ends of the headrail.
- Measure 1" from the end of the headrail and make a mark on the mounting surface.

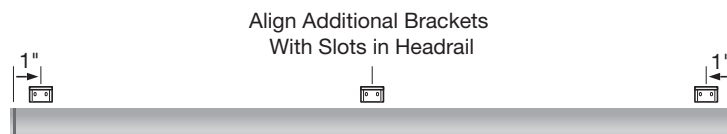

- On the shade, measure from the end of the headrail to the center of the additional slots on the headrail (if any). Make a mark on the wall for each slot measurement.

NOTE: Bracket placement is the same for inside and outside mounts.

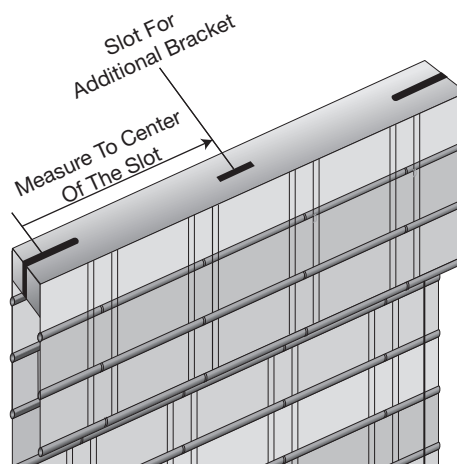

Inside Mount Applications

Use the mounting chart below to determine the mounting depth for your shade.

	Minimum Mounting Depth	Flush Mounting Depth
Cord	1½"	2¼"
Clutch	1⅞"	3¼"
Micropleat	1"	3½"

Bracket Installation

- Center each bracket over the previously made mark on the mounting surface.
- Adjust bracket placement to gain clearance to avoid any obstructions, such as window cranks or handles.
- Remove wing nuts.
- Attach using two screws through the top holes.
- The shade must be mounted level to operate properly. Use a level to ensure that all brackets are in line and level.

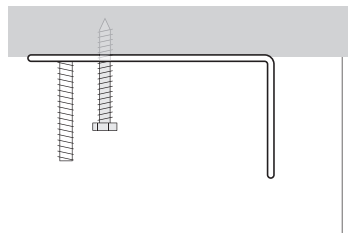

Outside Mount Applications

The minimum flat vertical surface needed for an outside mount is 1¼".

	Minimum Flat Surface
Cord	1" x 1⅞"
Clutch	1" x 1½"
Micropleat	1¾" x 1⅞"

Bracket Installation

- Center each bracket over the previously made marks on the mounting surface.
- Adjust bracket placement to gain clearance to avoid any obstructions, such as window cranks or handles.
- Remove wing nuts.
- Attach using two screws through the rear holes.
- The shade must be mounted level to operate properly. Use a level to ensure that all brackets are in line and level.

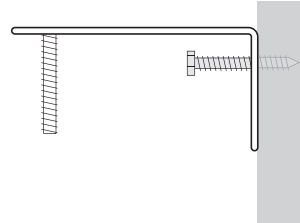

Specialty Ceiling Mount

A specialty ceiling mount bracket can be ordered separately.

Bracket Installation

- Center each bracket over the previously made marks on the mounting surface.
- Remove wing nuts.
- Attach using two screws through the top holes.
- The shade must be mounted level to operate properly. Use a level to ensure that all brackets are in line and level.



INSTALL THE SHADE

- If micropleat liner is included, snap the liner into the small clips located on the bracket.

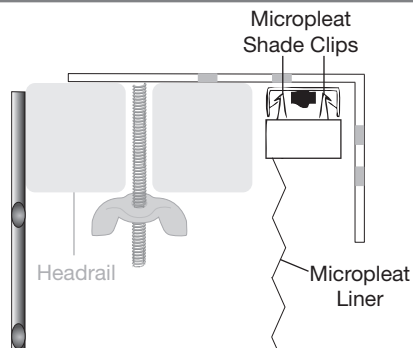

- Hold the shade so the valance faces you.
- Hold the shade up to the brackets, aligning the screws with the slots.
- Place the wing nuts onto the bolt, tighten them ½".
- If valance returns are included, slide the valance return between the headrail and the brackets.
- Tighten the wing nuts completely.
- Ensure the brackets securely hold the shade and the valance returns.

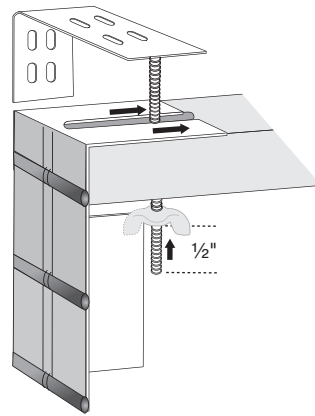

- Optional: remove the paper from the pressure sensitive tape. Smooth the valance down the sticky portion of the tape.

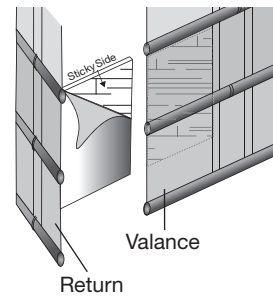

Clutch Operated Shades

- It is imperative that the cord tensioner be properly secured to the wall or window frame to reduce children's access to the beaded chain. Young children can strangle in beaded chains. They can also wrap cords around their necks and strangle.
- Furthermore, the shade will not operate properly unless the cord tensioner is secured. A cord tensioner installation kit has been included with your shade. Follow the instructions in the kit to correctly secure the cord tensioner.

IMPORTANT: See the Child Safety Section on page 10.

OPERATE THE SHADE

Standard Cord Operated Shades

To raise the shade:

- Hold the cord and pull until the shade is at the desired height.
- Pull the cord towards the outside of the shade to lock into position.

To lower the shade:

- Pull the cord towards the inside of the shade to unlock.
- Holding the cord, let the shade lower to the desired height.
- Pull the cord towards the outside of the shade to lock.

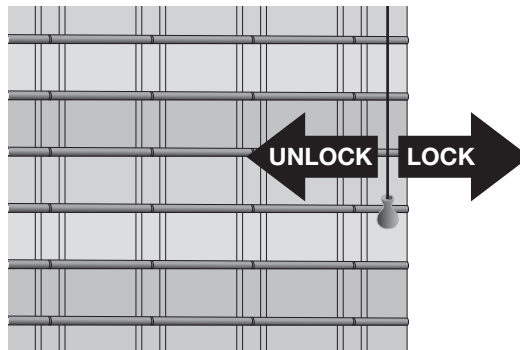

Clutch Operated Shades

- Pull one side of the cord loop to lower the shade.
- Pull the other side of the cord loop to raise the shade.
- If the cord tensioner moves up the cord, you have not secured it to the wall or window frame. You must do so for the shade to operate properly.

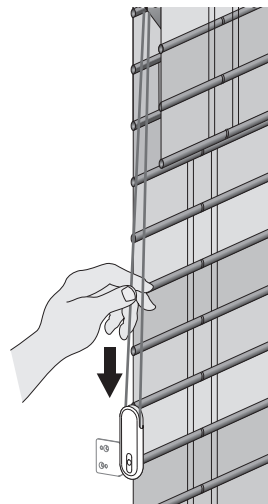

ADJUST THE SHADE

Adjust The Shade

- Lower the shade, then slowly raise it.
- If the shade is skewing, ensure you are pulling all the cords evenly.
- To level shade, gently pull on an individual cord until the bottom of the shade becomes level.

REMOVE THE SHADE

- Fully raise the shade.
- While holding the headrail, remove each wing nut from all screws on the brackets.

CARE AND CLEANING

Dusting

Regular light dusting with a feather duster or damp cloth is all the cleaning needed in most circumstances.

NOTE: Do not submerge the shade into water.

For more comprehensive cleaning instructions, call the Customer Information Center toll free at:

1-888-501-8364

CHILD SAFETY



! WARNING

For more safety information call 1-888-501-8364
in the U.S. or 1-866-662-0666 in Canada.

Standard Shades

Young children can STRANGLE in cord loops above the cord stop. They can also wrap cords around their necks and STRANGLE.

- Always keep cords out of the reach of children.
- Move cribs, playpens and other furniture away from cords. Children can climb furniture to get to cords.
- Do not tie cords together. Make sure cords do not twist together and create a loop.

Cord cleats are provided with the shade and we recommend their use.

- Cord Cleats: Attach two cord cleats 6" to 12" apart at a height where they will be out of the reach of children. Take into account that a child may stand on furniture attempting to reach the cords. Be sure the cleats are firmly secured.
- Once the cleats are attached, wrap excess cord around them after each use of the shade.



Clutch Operated Shades

Young children can STRANGLE in beaded chains. They can also wrap beaded chains around their necks and STRANGLE.

- Always keep cords out of the reach of children.
- Move cribs, playpens and other furniture away from beaded chains. Children can climb furniture to get to the beaded chain.
- Attach the cord tensioner on the cord loop to the wall or window casement. This can prevent children from pulling beaded chains around their necks.
- Hunter Douglas provides a cord tensioner installation kit with instructions for attaching the cord tensioner. For the shade to operate properly, the cord tensioner must be correctly mounted and secured.
- Only Hunter Douglas supplied cord tensioners and hardware should be used. Replacement parts may be obtained by contacting the Hunter Douglas Customer Information Center at 1-888-501-8364.

TROUBLESHOOTING

Breakaway Cord Stop

To further reduce the hazards of entanglement and strangulation, breakaway cord stops are provided with Top-Down/Bottom-Up shades. They are designed to break apart when force is applied from the top.

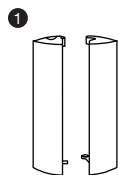

1
Breakaway
Cord Stop

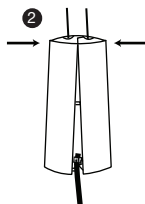

2
Fit the top
edges together.

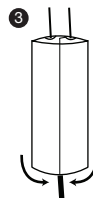

3
Swing the bottom
edges together
and snap closed.

NOTE: Should the Breakaway Cord Stop break apart, be sure to untangle the cords prior to reassembling.

Problem	Solution
The shade is skewing.	<ul style="list-style-type: none"> ■ Ensure you are pulling all cords evenly. ■ Gently pull on each individual cord until the bottom of the shade becomes level.
The universal cord tensioner has climbed to the top of the shade.	<ul style="list-style-type: none"> ■ Pull down on the spring to relieve tension and pull the universal cord tensioner to the bottom of the beaded chain. Properly mount the cord tensioner. See <i>Universal Cord Tensioner Installation Instructions</i>.
The universal cord tensioner grabs onto the cord upon operation.	<ul style="list-style-type: none"> ■ Check that the universal cord tensioner is mounted properly. Reinstall, if necessary.

**For assistance, call the Hunter Douglas
Customer Information Center
at 1-888-501-8364**

Visit our Web site at hunterdouglas.com



HunterDouglas

LIGHT CAN CHANGE EVERYTHING®

hunterdouglas.com

© 2007 Hunter Douglas Inc. ® Registered trademark of Hunter Douglas Inc.
Patented in the U.S. and foreign countries. Other U.S. and foreign patents pending.



LIT888230A

Rev. 10/07