

# Owner's Guide

---

## Designer Screen Roman Shades

---

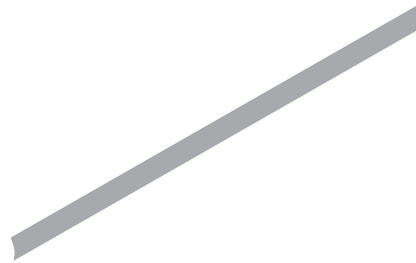

Cordlock Standard And Two-On-One Headrail,  
SoftGlide® And Standard Shades

**HunterDouglas**

## CONTENTS

Introduction.....	2
Before You Begin.....	2
Product View .....	3
Getting Started.....	4
Tools And Fasteners Needed.....	4
Mount The Installation Brackets .....	5
Install The Shade.....	8
Secure The Cord Tensioner .....	8
Operate The Shade.....	8
Attach The Accessories .....	9
Remove The Shade.....	10
Care And Cleaning.....	10
Child Safety .....	11
Troubleshooting .....	11

## INTRODUCTION

THANK YOU for purchasing a Hunter Douglas Roman shade. Your new shade has been custom built for you from the highest quality materials.

## BEFORE YOU BEGIN

Please review the instructions to acquaint yourself with all of the procedures.

If you need any assistance with operation or adjustments, call the Hunter Douglas Customer Information Center toll free at:

**1-888-501-8364**

**PRODUCT VIEW**



## GETTING STARTED



- Remove the materials from the package. Keep the packaging until the shade meets your satisfaction.
- Save these instructions for care and cleaning, shade removal, and reinstallation procedures.
- Check the *Product View* to make sure you have all of the necessary parts. Contents of the hardware package may vary depending upon how the shade was ordered and how the shade will be mounted.

## TOOLS AND FASTENERS NEEDED

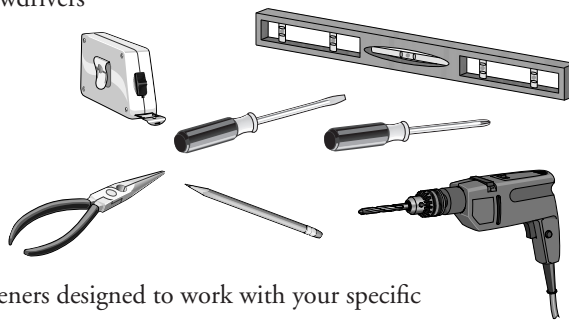
- Flat blade and Phillips screwdrivers
- Level
- Measuring tape
- Pencil
- Pliers
- Power drill, 1/4" driver, and drill bits





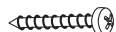

In addition, you will need fasteners designed to work with your specific mounting surfaces:

Mounting Surface	Fastener
Wood	No. 6 Hex Head Screws (Provided) 
Drywall, Plaster	Wall Anchors, Expansion Bolts (Not Provided) 
Metal	Sheet Metal Screws (Not Provided) 

# MOUNT THE INSTALLATION BRACKETS

## Bracket Requirements

Bracket Type	Brackets Required			
	18" to 36"	36 1/8" to 72"	72 1/8" to 96"	96 1/8" to 120"
 Installation Bracket	2	3	4	5
 Extension Bracket (Optional)				
 End Mount Bracket (Optional)	2			
 Hold-Down Bracket (Optional)	2			

## Bracket Placement

- Measure 2 1/2" in from where the ends of the headrail will be located and mark the bracket location on the mounting surface.

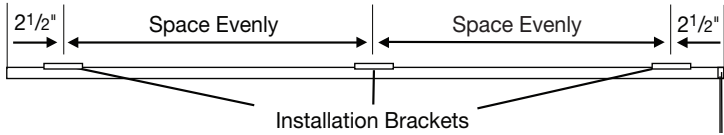

- Bracket spacing is the same for inside and outside mounts.

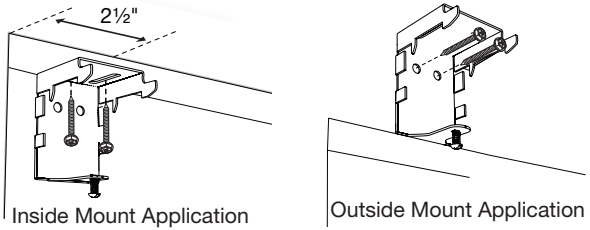

**NOTE:** Adjust bracket placement to avoid mounting installation brackets over the spool covers or cordlock in the headrail.

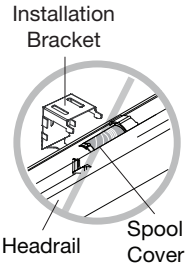

## Inside And Outside Mount Applications

- Minimum mounting depth for bracket attachment is  $\frac{3}{4}$ " for inside mount. Fully recessed mounting depth  $1\frac{1}{2}$ ".
- Minimum flat vertical surface for outside mount is  $\frac{7}{8}$ ".

### Bracket Installation

- Center each bracket over the previously made mark on the mounting surface.
- Adjust bracket placement to accommodate any obstructions to the bottom rail, such as window cranks or handles.
- Attach using the two screws provided.
- Check that each bracket is level and the front edges are aligned.

---

**NOTE:** Failure to level and align the brackets may prevent them from functioning properly.

---

### Extension Brackets (Optional)

Extension brackets project installation brackets up to  $1\frac{1}{4}$ " away from the mounting surface.

- Center each bracket over the previously made mark on the mounting surface.
- Adjust bracket placement to accommodate any obstructions to the bottom rail, such as window cranks or handles.
- Attach the extension bracket to the mounting surface using two screws.
- Use a level to check that the extension brackets are level and aligned.
- Attach installation brackets to the underside of extension brackets using the provided screws and nuts.

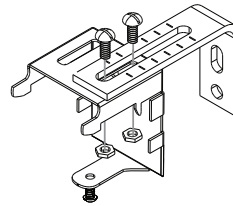

---

**NOTE:** Use the same screw holes on each extension bracket to ensure brackets are projected an equal distance from the mounting surface.

---

## End Mount Applications

End mount the headrail when conventional mounting techniques will not work. The minimum flat vertical surface required is 1".

- Lower the shade completely and hold it in the window opening at the ordered height.
- Keeping the headrail level, mark where the top of the headrail is in the opening.
- Be sure the marks on each side are the same height.

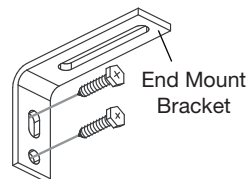

## Bracket Installation

- Align the top of each end mount bracket to the previously made mark on the mounting surface.
- Attach using two screws.
- Use a level to check that the extension brackets are level and aligned.
- Attach the installation bracket to the end mount bracket using screws and nuts.

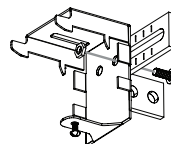

---

**CAUTION:** End mounting shades wider than 48" is not recommended.

---

## Attach The Valance (Optional)

- Align the valance flush with the top, left and right edges of the face of the headrail.
  - Flip valance fabric over the top of the head rail and slide the front tabs of the valance clip into place.
  - Press clips down and snap valance into place.

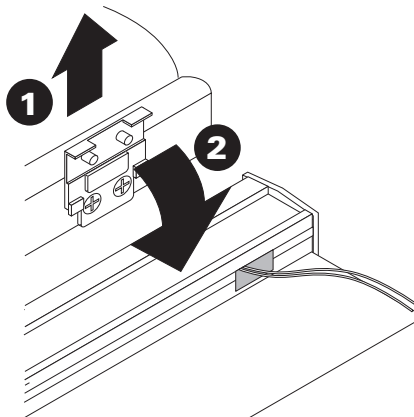
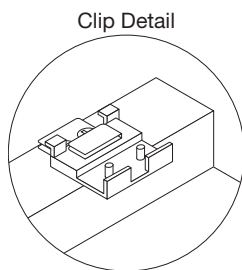

## INSTALL THE SHADE

- Large shades may require two people to install.
- With the colored side of the shade facing you, insert the front edge of the headrail onto the top of each installation bracket.
- Starting from the center, push upward and back until the back edge of the headrail snaps into the back tab of each installation bracket. Lower the shade slightly.
- Tighten the securing screw until the screw touches the bottom of the headrail. Be sure that pleated fabric is free from securing screw.

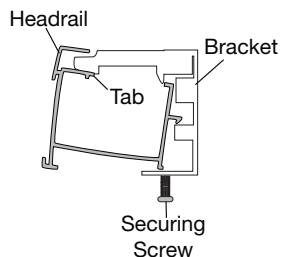

## SECURE THE CORD TENSIONER

- It is imperative that the cord tensioner be properly secured to the wall or window frame to reduce children's access to the cord loop. Young children can strangle in cord loops. They can also wrap cords around their necks and strangle.
- Furthermore, the shade will not operate properly unless the cord tensioner is secured. A cord tensioner installation kit has been included with your shade. Follow the instructions in the kit to correctly secure the cord tensioner.

**IMPORTANT:** See the Child Safety Section on page 11.

## OPERATE THE SHADE

### Standard Shade Operation

To raise the shade:

- Hold the cord and pull until the shade is at the desired height.
- Pull the cord towards the outside of the shade to lock into position.

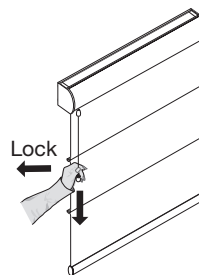

**To lower the shade:**

- Pull the cord towards the inside of the shade to unlock.
- Holding the cord, let the shade lower to the desired height.
- Pull the cord towards the outside of the shade to lock into position.

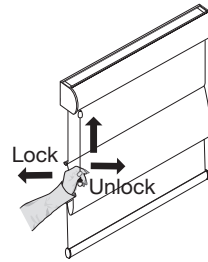

**SoftGlide® Operation**

**To lower the shade:**

- Hold the front cord and pull down.
- Pull until the shade is at the desired height.

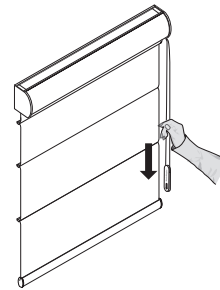

**To raise the shade:**

- Hold the back cord and pull down.
- Pull until the shade is at the desired height.

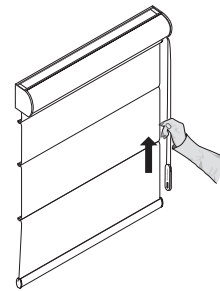

## ATTACH THE ACCESSORIES

### Attach The Hold-Down Brackets (Optional)

Hold-down brackets can only be used on outside-mounted shades.

- Lower the shade and place the pins from the hold-down brackets into the bottom rail end caps.
- On the mounting surface, mark the bracket hole locations.
- Attach using two screws.
- Check that the brackets are level.

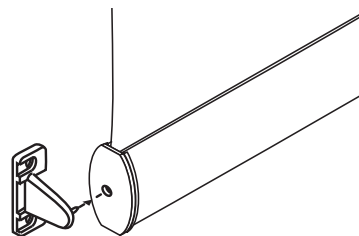

**NOTE:** Disconnect the bottom rail from the hold-down brackets to raise the shade.

## REMOVE THE SHADE

- Working left to right, unscrew the securing screw on each bracket.
- Turn the bottom of the headrail away from the bracket until the bracket clicks, then pull the headrail forward.

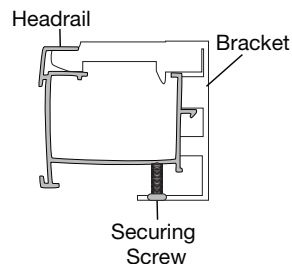

## CARE AND CLEANING

Roman shades are made of an anti-static, dust-resistant fabric which repels dirt and dust. For most fabrics, the following options are available if your shade needs cleaning.

### Dusting

Regular light dusting with a feather duster is all the cleaning that is needed in most circumstances.

### Vacuuming

Use a low suction, hand-held vacuum for more thorough dust removal.

### Spot-Cleaning

- Prepare a solution of warm water and a mild detergent.
- Dampen a clean cloth in the solution and wring it out.
- Dab the spot with the dampened cloth until it is gone. **Do not rub the fabric.**
- Allow the shade to dry in the completely lowered position.

For more comprehensive cleaning instructions, call the Hunter Douglas Customer Information Center toll free at:

**1-888-501-8364**

## CHILD SAFETY



# ! WARNING

**For more safety information call 1-888-501-8364 in the U.S. or 1-866-662-0666 in Canada.**

### Standard Shades

Young children can STRANGLE in cord loops above the cord stop. They can also wrap cords around their necks and STRANGLE.

- Always keep cords out of the reach of children.
- Move cribs, playpens and other furniture away from cords. Children can climb furniture to get to cords.
- Do not tie cords together. Make sure cords do not twist together and create a loop.

Cord cleats are provided with the shade and we recommend their use.

- Cord Cleats: Attach two cord cleats 6" to 12" apart at a height where they will be out of the reach of children. Take into account that a child may stand on furniture attempting to reach the cords. Be sure the cleats are firmly secured.
- Once the cleats are attached, wrap excess cord around them after each use of the shade.



## TROUBLESHOOTING

Problem	Solution
The shade does not raise and lower evenly.	<ul style="list-style-type: none"> <li>■ Make sure the mounting brackets are level and aligned.</li> </ul>
The shade will not raise.	<ul style="list-style-type: none"> <li>■ Ensure the hold-down brackets have been released.</li> </ul>
The universal cord tensioner has climbed to the headrail.	<ul style="list-style-type: none"> <li>■ Pull down on the spring to relieve tension and pull the universal cord tensioner to the bottom of the cord loop. Properly mount the cord tensioner. See <i>Universal Cord Tensioner Installation Instructions</i>.</li> </ul>
The universal cord tensioner grabs onto the cord upon operation.	<ul style="list-style-type: none"> <li>■ Check that the universal cord tensioner is mounted properly. Reinstall, if necessary.</li> </ul>

**For assistance, call the Hunter Douglas  
Customer Information Center  
at 1-888-501-8364**

**Visit our Web site at [hunterdouglas.com](http://hunterdouglas.com)**



# **HunterDouglas**

**LIGHT CAN CHANGE EVERYTHING®**

[hunterdouglas.com](http://hunterdouglas.com)

© 2007 Hunter Douglas Inc. ® Registered trademark of Hunter Douglas Inc.  
Patented in the U.S. and foreign countries.  
Other U.S. and foreign patents pending.



LIT888219D

Rev. 4/08